







DATASHEET
Compact
enclosures
WME, WME-G

CONTEG

INDUSTRIAL ENCLOSURES AND THEIR APPLICATION

➤ **CONTEG** offers a comprehensive range of industrial enclosures, that meet all of the requirements for application in even the most demanding industrial environments. We offer not only compact sheet steel enclosures, but also large, free-standing enclosures suitable for connecting in rows. You can choose from many sizes and four types of materials, it depends only on the area of use. All series of enclosures meet the high degree of coverage requirements. Industrial enclosures are manufactured in our production plant in Pelhrimov using state-of-the-art technological processes, thanks to which they have first-class functional properties, mechanical resistance and long service life.

	INDUSTRIAL ENCLOSURES					
	FSE sheet steel	FSM sheet steel	FSM-X stainless steel	WME sheet steel	WME-G glass-paneled doors	WME-X stainless steel
						
Application	Indoor installation	Indoor installation	Indoor installation Outdoor installation Food and chemical industry	Indoor installation	Indoor installation	Indoor installation Outdoor installation Food and chemical industry
Material	Sheet steel	Sheet steel	Stainless steel 1.4301 (AISI 304) Stainless steel 1.4404 (AISI 316L)	Sheet steel	Sheet steel, with glass-paneled doors	Stainless steel 1.4301 (AISI 304) Stainless steel 1.4404 (AISI 316L)
Version	Single-door Double-door	Single-door Double-door	Single-door Double-door	Single-door Double-door	Single-door Double-door	Single-door Double-door
IP rating	IP55	IP55	IP55	IP66 IP55	IP66 IP55	IP66 IP55
Mechanical durability	IK10	IK10	IK10	IK10	IK10 IK8	IK10
Color	RAL 7035	RAL 7035	–	RAL 7035	RAL 7035	–
Surface finish	Epoxypolyester powder coating	Epoxypolyester powder coating	Fine ground surface	Epoxypolyester powder coating	Epoxypolyester powder coating	Fine ground surface



Many applications in the areas of measurement and control, automation, machine and plant control require that the temperature within the racks is controllable.

We calculate the required cooling/heating power to maintain stable thermal comfort for the installed elements inside the enclosures and we then recommend you the appropriate sort of cooling.

- Wall and top mount air conditioning units—cooling capacity from 320 W to 4 000 W
- Thermoelectric unit—cooling and heat output up to 800 W
- Filter fans—air flow 12 to 800 m³/h
- Heating units—permanent heating output 45 to 800 W

SHEET STEEL AND WITH GLAZED DOORS



WME-050503



WME-181003



➤ **WME and WME-G compact enclosures** made of sheet steel are suitable for indoor spaces for a variety of applications in industry and electrical engineering. Our wide range of enclosure sizes with both full metal or glass-paneled doors, in one or two door design, are complemented by a rich assortment of accessories. The structural design of the series offers high rigidity of not just the back panel but the entire enclosure. Manufacturing by laser welding technology lends the enclosures a clean design. CONTEG can also create cut-outs and threads required for installations into enclosures on request.

MAIN ADVANTAGES

- Single-door/double-door enclosure, door hinges are located on the right side of a single-door enclosure (easy to change door opening from right to left)
- The doors are equipped with a polyurethane foam seal all around the perimeter and a rotary lock or three-point locking system
- Cable gland plate/bottom
- Perforated mounting rails on side panels (for enclosures 250 mm in depth and deeper)
- Mounting plate with a 50 × 50 mm marked raster
- Accessories for wall-mounting

COLOR:  RAL 7035

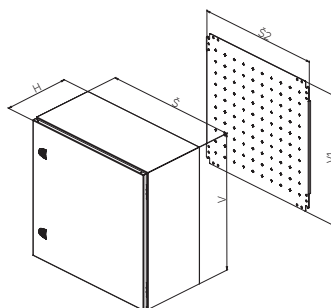
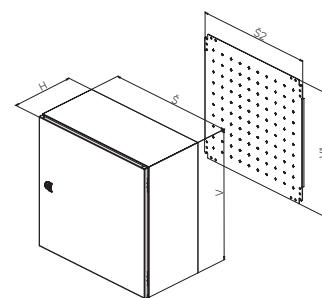
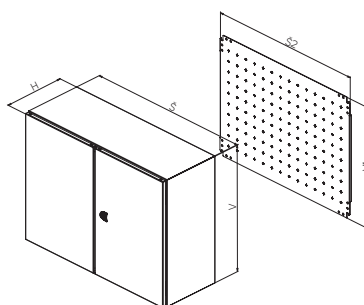

DESCRIPTION

Material

- Enclosure: sheet steel
- Mounting plate: zinc-plated sheet steel
- Glass-paneled version: 4mm hardened clear glass according to ČSN EN 12150

Enclosure surface finish

- Epoxypolyester powder coating

Color

- RAL 7035 for indoor use

Degree of protection

- IP66 single-door version/IP55 two-door version according to EN 60529 (degree of protection may be reduced after mounting some accessories)

Mechanical durability

- IK10 according to IEC 62262
- IK08 (for glass)

Supply includes

- Single-door/double-door enclosure, door hinges are located on the right side of a single-door enclosure (easy to change door opening from right to left).
- The doors are equipped with a polyurethane foam seal all around the perimeter and a rotary lock or three-point locking system.
- Gland plate(s)

- Perforated mounting rails on the doors of enclosures 500 mm in height and higher
- Perforated mounting rails on the side panels of enclosures 250 mm in depth and deeper
- Mounting plate with a marked raster 50 × 50 mm
- Accessories for wall-mounting

WME, WME-G—COMPACT ENCLOSURES, SINGLE-DOOR, HEIGHT 300 mm							
Enclosure	H (mm)	300	300	300	300	300	300
	W (mm)	200	250	300	300	400	400
	D (mm)	155	155	155	210	155	210
Mounting plate	H1 (mm)	270	270	270	270	270	270
	W2 (mm)	150	200	250	250	350	350
Material thickness (mm)	Enclosure body	1.25	1.25	1.25	1.25	1.25	1.25
	Door	1.5	1.5	1.5	1.5	1.5	1.5
	Mounting plate	2	2	2	2	2	2
Number	Hinges	2	2	2	2	2	2
	Cam locks	1	1	1	1	1	1
	Bolts	4	4	4	4	4	4
Cable gland plate	Size	A	A	B	C	B	D
	Number	1	1	1	1	1	1
Weight (kg)		3.9	4.7	5.5	6.1	6.9	7.7
Code	1 pc	WME-030215	WME-032515	WME-030315	WME-030321	WME-030415	WME-030421
GLAZED DOOR VERSION							
Code	1 pc	–	WME-G-032515	WME-G-030315	WME-G-030321	WME-G-030415	WME-G-030421

WME, WME-G—COMPACT ENCLOSURES, SINGLE-DOOR, HEIGHT 400 mm							
Enclosure	H (mm)	400	400	400	400	400	400
	W (mm)	300	300	400	600	600	600
	D (mm)	155	210	210	210	250	250
Mounting plate	H1 (mm)	370	370	370	370	370	370
	W2 (mm)	250	250	350	550	550	550
Material thickness (mm)	Enclosure body	1.25	1.25	1.25	1.25	1.25	1.25
	Door	1.5	1.5	1.5	1.5	1.5	1.5
	Mounting plate	2	2	2.5	2.5	2.5	2.5
Number	Hinges	2	2	2	2	2	2
	Cam locks	1	1	1	1	1	1
	Bolts	4	4	4	4	4	4
Cable gland plate	Size	B	C	D	F	F	F
	Number	1	1	1	1	1	1
Weight (kg)		6.9	7.6	9.5	13.4	14.2	14.2
Code	1 pc	WME-040315	WME-040321	WME-040421	WME-040621	WME-040625	WME-040625
GLAZED DOOR VERSION							
Code	1 pc	WME-G-040315	WME-G-040321	WME-G-040421	WME-G-040621	WME-G-040625	WME-G-040625
ACCESSORIES							
Rails for interior installation	1 set	–	–	–	–	–	ID-W-H4
19" fixed extrusions	1 set	–	–	–	–	–	ID-W-U8

WME, WME-G—COMPACT ENCLOSURES, SINGLE-DOOR, HEIGHT 500 mm						
Enclosure	H (mm)	500	500	500	500	500
	W (mm)	300	400	400	500	500
	D (mm)	210	210	250	210	300
Mounting plate	H1 (mm)	470	470	470	470	470
	W2 (mm)	250	350	350	450	450
Material thickness (mm)	Enclosure body	1.25	1.25	1.25	1.25	1.25
	Door	1.5	1.5	1.5	1.5	1.5
	Mounting plate	2	2.5	2.5	2.5	2.5
Number	Hinges	2	2	2	2	2
	Cam locks	1	1	1	1	1
	Bolts	4	4	4	4	4
Cable gland plate	Size	C	D	D	E	E
	Number	1	1	1	1	1
Weight (kg)		9.1	11.3	12.1	13.7	15.5
Code	1 pc	WME-050321	WME-050421	WME-050425	WME-050521	WME-050503
GLAZED DOOR VERSION						
Code	1 pc	WME-G-050321	WME-G-050421	WME-G-050425	WME-G-050521	WME-G-050503
ACCESSORIES						
Rails for interior installation	1 set	–	–	ID-W-H5	–	ID-W-H5
Door-mounting rails	1 set	ID-W-VD3	ID-W-VD4	ID-W-VD4	ID-W-VD5	ID-W-VD5
Interior door	1 pc	–	–	ID-W-ID54	–	ID-W-ID55

WME, WME-G—COMPACT ENCLOSURES, SINGLE-DOOR, HEIGHT 600 mm						
Enclosure	H (mm)	600	600	600	600	600
	W (mm)	400	400	400	400	500
	D (mm)	210	250	300	300	250
Mounting plate	H1 (mm)	570	570	570	570	570
	W2 (mm)	350	350	350	350	450
Material thickness (mm)	Enclosure body	1.25	1.5	1.5	1.5	1.5
	Door	1.5	1.5	1.5	1.5	1.5
	Mounting plate	2.5	2.5	2.5	2.5	2.5
Number	Hinges	2	2	2	2	2
	Cam locks	2	2	2	2	2
	Bolts	4	4	4	4	4
Cable gland plate	Size	D	D	D	D	E
	Number	1	1	1	1	1
Weight (kg)		13.2	15.4	16.8	16.8	18.4
Code	1 pc	WME-060421	WME-060425	WME-060403	WME-060403	WME-060525
GLAZED DOOR VERSION						
Code	1 pc	WME-G-060421	WME-G-060425	WME-G-060403	WME-G-060403	WME-G-060525
ACCESSORIES						
Rails for interior installation	1 set	–	ID-W-H6	ID-W-H6	ID-W-H6	ID-W-H6
Door-mounting rails	1 set	ID-W-VD4	ID-W-VD4	ID-W-VD4	ID-W-VD4	ID-W-VD5
19" fixed extrusions	1 set	–	–	–	–	–
Interior door	1 pc	–	ID-W-ID64	ID-W-ID64	ID-W-ID64	ID-W-ID65
Plinth **	front and rear	1 set	–	–	–	–
	side parts	1 set	–	–	–	–

* Don't forget to order the ID-W-UB console. ** Plinth steel version, height 100 mm, RAL 7046.

WME, WME-G—COMPACT ENCLOSURES, SINGLE-DOOR, HEIGHT 600 mm								
Enclosure	H (mm)	600	600	600	600	600	600	
	W (mm)	600	600	600	600	800	800	
	D (mm)	210	250	300	400	250	300	
Mounting plate	H1 (mm)	570	570	570	570	570	570	
	W2 (mm)	550	550	550	550	750	750	
Material thickness (mm)	Enclosure body	1.5	1.5	1.5	1.5	1.5	1.5	
	Door	1.5	1.5	1.5	1.5	1.5	1.5	
	Mounting plate	2.5	2.5	2.5	2.5	2.5	2.5	
Number	Hinges	2	2	2	2	2	2	
	Cam locks	2	2	2	2	2	2	
	Bolts	4	4	4	4	4	4	
Cable gland plate	Size	F	F	F	F	F	F	
	Number	1	1	1	1	1	1	
Weight (kg)		20.3	21.4	22.8	25.9	27.3	29	
Code	1 pc	WME-060621	WME-060625	WME-060603	WME-060604	WME-060825	WME-060803	
GLAZED DOOR VERSION								
Code	1 pc	WME-G-060621	WME-G-060625	WME-G-060603	WME-G-060604	WME-G-060825	WME-G-060803	
ACCESSORIES								
Rails for interior installation	1 set	–	ID-W-H6	ID-W-H6	ID-W-H6	ID-W-H6	ID-W-H6	
Door-mounting rails	1 set	ID-W-VD6	ID-W-VD6	ID-W-VD6	ID-W-VD6	ID-W-VD8	ID-W-VD8	
19" fixed extrusions	1 set	–	ID-W-U12	ID-W-U12	ID-W-U12	ID-W-U12 *	ID-W-U12 *	
Interior door	1 pc	–	ID-W-ID66	ID-W-ID66	ID-W-ID66	–	–	
Plinth **	front and rear	1 set	–	–	ID-W-PF60	ID-W-PF60	–	ID-W-PF80
	side parts	1 set	–	–	ID-W-PS30	ID-W-PS40	–	ID-W-PS30

* Don't forget to order the ID-W-UB console. ** Plinth steel version, height 100 mm, RAL 7046.

WME, WME-G—COMPACT ENCLOSURES, SINGLE-DOOR, HEIGHT 700 AND 800 mm

Enclosure	H (mm)	700	700	800	800	800	800	800
	W (mm)	500	500	600	600	600	800	800
	D (mm)	210	300	250	300	400	300	400
Mounting plate	H1 (mm)	670	670	770	770	770	770	770
	W2 (mm)	450	450	550	550	550	750	750
Material thickness (mm)	Enclosure body	1.5	1.5	1.5	1.5	1.5	1.5	1.5
	Door	1.5	1.5	2	2	2	2	2
	Mounting plate	2.5	2.5	3 F	3 F	3 F	3 FF	3 FF
Number	Hinges	2	2	2	2	2	2	2
	Cam locks	2	2	2	2	2	2	2
	Bolts	4	4	4	4	4	4	4
Cable gland plate	Size	E	E	F	F	F	F	F
	Number	1	1	1	1	1	1	1
Weight (kg)		19.8	22.3	29.2	31.7	35.2	40.2	44.2
Code	1 pc	WME-070521	WME-070503	WME-080625	WME-080603	WME-080604	WME-080803	WME-080804

GLAZED DOOR VERSION

Code	1 pc	WME-G-070521	WME-G-070503	WME-G-080625	WME-G-080603	WME-G-080604	WME-G-080803	WME-G-080804
------	------	--------------	--------------	--------------	--------------	--------------	--------------	--------------

ACCESSORIES

Rails for interior installation	1 set	–	ID-W-H7	ID-W-H8	ID-W-H8	ID-W-H8	ID-W-H8	ID-W-H8
Door-mounting rails	1 set	ID-W-VD5	ID-W-VD5	ID-W-VD6	ID-W-VD6	ID-W-VD6	ID-W-VD8	ID-W-VD8
19" fixed extrusions	1 set	–	–	ID-W-U17	ID-W-U17	ID-W-U17	ID-W-U17 *	ID-W-U17 *
Interior door	1 pc	–	ID-W-ID75	ID-W-ID86	ID-W-ID86	ID-W-ID86	ID-W-ID88	ID-W-ID88
Plinth **	front and rear	1 set	–	–	ID-W-PF60	ID-W-PF60	ID-W-PF80	ID-W-PF80
	side parts	1 set	–	–	ID-W-PS30	ID-W-PS40	ID-W-PS30	ID-W-PS40

3 F—3mm mounting plate with 2 bent edges. 3 FF—3mm mounting plate with 4 bent edges.

* Don't forget to order the ID-W-UB console. ** Plinth steel version, height 100 mm, RAL 7046.

WME, WME-G—COMPACT ENCLOSURES, SINGLE-DOOR, HEIGHT 1000 mm

Enclosure	H (mm)	1000	1000	1000	1000	1000
	W (mm)	600	600	600	800	800
	D (mm)	250	300	400	300	400
Mounting plate	H1 (mm)	970	970	970	970	970
	W2 (mm)	550	550	550	750	750
Material thickness (mm)	Enclosure body	1.5	1.5	1.5	1.5	1.5
	Door	2	2	2	2	2
	Mounting plate	3 F	3 F	3 F	3 FF	3 FF
Number	Hinges	3	3	3	3	3
	Bolts	4	4	4	6	6
3-point locking system		+	+	+	+	+
Cable gland plate	Size	F	F	F	F	F
	Number	1	1	1	1	1
Weight (kg)		35.7	38.4	42.4	48.6	53.1
Code	1 pc	WME-100625	WME-100603	WME-100604	WME-100803	WME-100804

GLAZED DOOR VERSION

Code	1 pc	WME-G-100625	WME-G-100603	WME-G-100604	WME-G-100803	WME-G-100804
------	------	--------------	--------------	--------------	--------------	--------------

ACCESSORIES

Rails for interior installation	1 set	ID-W-H10	ID-W-H10	ID-W-H10	ID-W-H10	ID-W-H10
Door-mounting rails	1 set	ID-W-VD6	ID-W-VD6	ID-W-VD6	ID-W-VD8	ID-W-VD8
19" fixed extrusions	1 set	ID-W-U21	ID-W-U21	ID-W-U21	ID-W-U21 *	ID-W-U21 *
Interior door	1 pc	ID-W-ID106	ID-W-ID106	ID-W-ID106	ID-W-ID108	ID-W-ID108
Plinth **	front and rear	1 set	–	ID-W-PF60	ID-W-PF60	ID-W-PF80
	side parts	1 set	–	ID-W-PS30	ID-W-PS40	ID-W-PS30

3 F—3mm mounting plate with 2 bent edges. 3 FF—3mm mounting plate with 4 bent edges.

* Don't forget to order the ID-W-UB console. ** Plinth steel version, height 100 mm, RAL 7046.

WME, WME-G—COMPACT ENCLOSURES, DOUBLE-DOOR, HEIGHT 1200 – 1400 mm

Enclosure	H (mm)	1200	1200	1200	1200	1400
	W (mm)	1000	1000	1200	1200	1000
	D (mm)	300	400	300	400	300
Mounting plate	H1 (mm)	1170	1170	1170	1170	1370
	W2 (mm)	950	950	1150	1150	950
Material thickness (mm)	Enclosure body	1.5	1.5	1.5	1.5	1.5
	Door	2	2	2	2	2
	Mounting plate	3 FF	3 FF	3 FF	3 FF	3 FF
Number	Hinges	3	3	3	3	3
	Bolts	6	6	6	6	6
3-point locking system		+	+	+	+	+
Cable gland plate	Size	E	E	F	F	E
	Number	2	2	2	2	2
Weight (kg)		74.7	80.2	87.6	93.4	85.8
Code	1 pc	WME-221003	WME-221004	WME-221203	WME-221204	WME-241003
GLAZED DOOR VERSION						
Code	1 pc	WME-G-221003	WME-G-221004	WME-G-221203	WME-G-221204	WME-G-241003
ACCESSORIES						
Rails for interior installation	1 set	ID-W-H12	ID-W-H12	ID-W-H12	ID-W-H12	ID-W-H14
Door-mounting rails	1 set	–	–	–	–	–
19" fixed extrusions	1 set	–	–	–	–	–
Plinth **	front and rear	1 set	ID-W-PF100	ID-W-PF100	ID-W-PF120	ID-W-PF100
	side parts	1 set	ID-W-PS30	ID-W-PS40	ID-W-PS30	ID-W-PS40

3 FF—3mm mounting plate with 4 bent edges.

* Don't forget to order the ID-W-UB console. ** Plinth steel version, height 100 mm, RAL 7046.



ACCESSORIES

RAILS FOR INTERIOR INSTALLATION

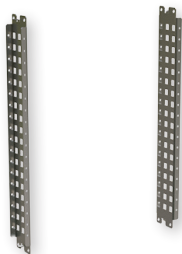

- Material: 2mm zinc-plated sheet steel with 25 mm perforation
- Rail width: 75 mm
- Mounting: onto interior rails, which are part of the enclosure
- Application: for distributors 250 mm deep and deeper and 400 mm in height and higher
- Supply includes: 2 mounting rails and accessories

Code	For enclosure height (mm)	Package *
ID-W-H4	400	1 set
ID-W-H5	500	1 set
ID-W-H6	600	1 set
ID-W-H7	700	1 set
ID-W-H8	800	1 set
ID-W-H10	1000	1 set
ID-W-H12	1200	1 set
ID-W-H14	1400	1 set

* 1 set—2 pieces.

19" FIXED EXTRUSIONS



- Material: 2mm zinc-plated sheet steel
- Rail width: 56 mm
- Mounting: onto interior rails, which are part of the enclosure or onto the wall-mounting bracket ID-W-UD for enclosures 800 mm in width
- Application: for enclosures 250 mm deep and deeper and 600 and 800 mm wide
- Supply includes: 19" fixed extrusions and mounting accessories

Code	For enclosure height (mm)	Package *
ID-W-U8	400 (8U)	1 set
ID-W-U12	600 (12U)	1 set
ID-W-U17	800 (17U)	1 set
ID-W-U21	1000 (21U)	1 set
ID-W-U25	1200 (25U)	1 set

* 1 set—2 pieces.

For enclosure width 800 mm, it's necessary to order the ID-W-UB wall-mounting brackets, packing contains 4 pcs.

DOOR-MOUNTING RAILS

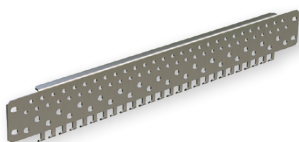

- Material: 2mm zinc-plated sheet steel
- Rail width: 61 mm (including door-mounting rails)
- Mounting: onto rails for interior installation, which are part of the enclosure door
- Application: for enclosures 500 mm high and higher
- Supply includes: 2 pcs door-mounting rails and mounting accessories

Code	For enclosure width (mm)	Package *
ID-W-VD3	300	1 set
ID-W-VD4	400	1 set
ID-W-VD5	500	1 set
ID-W-VD6	600	1 set
ID-W-VD8	800	1 set

* 1 set—2 pieces.

SPARE MOUNTING PLATE



- Material: zinc-plated sheet steel
- Supply includes: mounting plate with marked raster 50 × 50 mm (securing materials in enclosure accessories)

Code	For sizes of enclosures H × W (mm)	Thickness of the material (mm)
ID-W-SP3020	300 × 200	2
ID-W-SP3025	300 × 250	2
ID-W-SP3030	300 × 300	2
ID-W-SP3040	300 × 400	2
ID-W-SP4030	400 × 300	2
ID-W-SP4040	400 × 400	2.5
ID-W-SP4060	400 × 600	2.5
ID-W-SP5030	500 × 300	2
ID-W-SP5040	500 × 400	2.5
ID-W-SP5050	500 × 500	2.5
ID-W-SP6040	600 × 400	2.5
ID-W-SP6050	600 × 500	2.5
ID-W-SP6060	600 × 600	2.5
ID-W-SP6080	600 × 800	2.5
ID-W-SP7050	700 × 500	2.5

Code	For sizes of enclosures H × W (mm)	Width of the material (mm)
ID-W-SP8060	800 × 600	3 F
ID-W-SP8080	800 × 800	3 FF
ID-W-SP8010	800 × 1000	3 FF
ID-W-SP8012	800 × 1200	3 FF
ID-W-SP1060	1000 × 600	3 F
ID-W-SP1080	1000 × 800	3 FF
ID-W-SP1010	1000 × 1000	3 FF
ID-W-SP1012	1000 × 1200	3 FF
ID-W-SP1260	1200 × 600	3 F
ID-W-SP1280	1200 × 800	3 FF
ID-W-SP1210	1200 × 1000	3 FF
ID-W-SP1212	1200 × 1200	3 FF
ID-W-SP1410	1400 × 1000	3 FF

3 F—3mm mounting plate with 2 bent edges.
3 FF—3mm mounting plate with 4 bent edges.

BRACKETS FOR ADJUSTING MOUNTING PLATE



- Material: 2mm zinc-plated sheet steel
- Mounting: onto rails for interior installation, which are part of the enclosure
- Application: for enclosures 250 mm deep and deeper
- Supply includes: 4 wall-mounting brackets and mounting accessories

Code	Package
ID-W-AMB	4 pcs

Only for enclosures with 4 bolts.

INTERIOR DOOR



- Material: 1.5 mm sheet steel
- Surface finish: epoxypolyester powder coating
- Degree of protection: IP20
- Color: RAL 7035
- Mounting: onto rails for interior installation, which are part of the enclosure
- Application: for single-door enclosures 250 mm in depth and deeper
- Lock: 3 mm double bar, 2 resp. 3 hinges
- Load capacity 20kg
- Supply includes: Interior door mounting accessories

Code	For enclosure height × width (mm)
ID-W-ID54	500 × 400
ID-W-ID55	500 × 500
ID-W-ID64	600 × 400
ID-W-ID65	600 × 500
ID-W-ID66	600 × 600
ID-W-ID75	700 × 500
ID-W-ID86	800 × 600
ID-W-ID88	800 × 800
ID-W-ID106	1000 × 600
ID-W-ID108	1000 × 800
ID-W-ID126	1200 × 600
ID-W-ID128	1200 × 800

GLASS-PANELED DOOR



- Material: 1.5mm sheet steel, viewing door: 4mm hardened glass according to ČSN EN 12150, transparent
- Surface finish: epoxypolyester powder coating
- Color: RAL 7035
- Lock: 3 mm double bar, 2 resp. 3 hinges
- Mounting: onto rails for interior installation, which are part of the enclosure
- Supply includes: viewing door and mounting accessories

Code	For enclosure height × width (mm)
ID-W-TD43	400 × 300
ID-W-TD44	400 × 400
ID-W-TD54	500 × 400
ID-W-TD55	500 × 500
ID-W-TD64	600 × 400
ID-W-TD65	600 × 500
ID-W-TD66	600 × 600
ID-W-TD75	700 × 500
ID-W-TD86	800 × 600
ID-W-TD88	800 × 800
ID-W-TD106	1000 × 600
ID-W-TD108	1000 × 800
ID-W-TD126	1200 × 600
ID-W-TD128	1200 × 800

LOCKS/LOCK INSERTS



ID-W-INSS



Double bit



Square



Triangular

Code	Typ	Material	Package
ID-W-INSS	Spare rotary lock WME	–	1 set*
ID-W-INLK	T handle with a lock for WME, key 5333	chrome plated ZAMAK	1 set**
ID-W-INLK1	Lock for WME, key 444	chrome plated ZAMAK	1 set**
ID-W-INLK2	Lock for WME, unique key	chrome plated ZAMAK	1 set**
ID-W-INLK3	Handle with lock for WME, key 5333	chrome plated ZAMAK	1 set**
ID-W-IND3	3 mm "Double bit"	black ZAMAK	1 pc
ID-W-INS6	6 mm square	black ZAMAK	1 pc
ID-W-INS7	7 mm square	black ZAMAK	1 pc
ID-W-INS8	8 mm square	black ZAMAK	1 pc
ID-W-INT7	7 mm triangle	black ZAMAK	1 pc
ID-W-INT8	8 mm triangle	black ZAMAK	1 pc
ID-W-INT9	9 mm triangle	black ZAMAK	1 pc
ID-W-INLKE1	Lockable closure VW 1	chrome plated ZAMAK	1 set**

* Complete replacement rotary double bit lock kit 5 mm with double bar.

** Complete set of cam lock with double bar.

WALL-MOUNTING BRACKETS

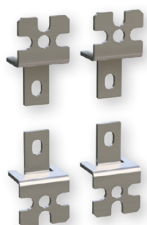

- Material: 3mm stainless steel (ID-W-WB) or zinc-plated sheet metal (ID-W-WBZN)
- Load capacity: 100 kg
- Supply includes: 4 pcs brackets and mounting material to mount onto enclosure

Code	Package
ID-W-WB	4 pcs
ID-W-WBZN	4 pcs

PLINTH



- Height: 100 mm
- Material: 2,5mm sheet steel
- Surface finish: epoxypolyester powder coating
- Possibility of installing two plinths on top of each other (max. 4pcs)
- Supply includes: Plinth and accessories (set ID-W-PFxx/ID-W-PSxx)

Code	For enclosure depth (mm)	Material	Color	Package
Plinth steel—side kit				
ID-W-PS30	300	steel	RAL 7046	1 set *
ID-W-PS40	400	steel	RAL 7046	1 set *
ID-W-PS30G	300	steel	RAL 7035	1 set *
ID-W-PS40G	400	steel	RAL 7035	1 set *

* 1 set contains 2 sides and mounting accessories.

Code	For enclosure width (mm)	Material	Color	Package
Plinth steel—front and rear kit				
ID-W-PF60	600	steel	RAL 7046	1 set **
ID-W-PF80	800	steel	RAL 7046	1 set **
ID-W-PF100	1000	steel	RAL 7046	1 set **
ID-W-PF120	1200	steel	RAL 7046	1 set **
ID-W-PF60G	600	steel	RAL 7035	1 set **
ID-W-PF80G	800	steel	RAL 7035	1 set **
ID-W-PF100G	1000	steel	RAL 7035	1 set **
ID-W-PF120G	1200	steel	RAL 7035	1 set **

** 1 set contains 1 pcs front and 1 pcs rear and mounting accessories.

POLE-MOUNTING BRACKETS



- Material: 2mm stainless steel sheet
- Mounting: for poles that are 250 mm in diameter
- Load capacity: 200 kg
- Supply includes: Pole-mounting brackets mounting accessories (2 pcs profile rails, 2 pcs clamping straps(l=850 mm), 8 sets: screws M8×12, self-locking nuts and washers adhesion)

Code	For enclosure width (mm)
ID-W-MP2	200
ID-W-MP25	250
ID-W-MP3	300
ID-W-MP4	400
ID-W-MP5	500
ID-W-MP6	600

DOOR STOP



- Material: 2mm zinc-plated sheet steel
- Application: for enclosures 500 mm in height and higher and 250 mm deep and deeper
- Supply includes: door stop and mounting accessories

Code	Package
ID-W-DS	1 pc

DOOR SWITCH



- Material—brackets: 2mm zinc-plated sheet steel
- Door switch: IP65, plastic, 1NO + 1NC, PG13.5, -25°C to +70°C
- Application: for enclosures 500 mm high and higher and 250 mm deep and deeper
- Supply includes: door switch and mounting accessories

Code	Package
ID-W-DC	1 pc

POCKET FOR DOCUMENTS



- Material: ABS
- Color: RAL 7035
- Dimensions: 234 × 241 × 31 mm (H × W × D)
- Mounting: self-adhesive tape
- Supply includes: pocket for documents including self-adhesive tape

Code	Package
ID-PO-A4	1 pc

LIGHTING UNIT

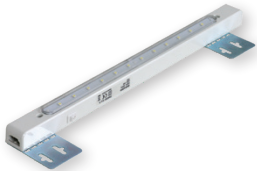

- Degree of protection: IP20
- Mounting: onto mounting plate, side of rails
- Technology LED, 12 illuminated spots
- Dimensions: 400 × 26 × 27 mm (W × H × D)
- Supply includes:
 - inter-connection cables
 - brackets for mounting plate for fitting the lighting unit near the top in various depths

Code	Type	Package
ID-W-L	3W, 230 W, 50 Hz	1 pc

DRAINAGE DEVICE



- Material: plastic according to UL94V-0, dark grey, waterproof with UV protection
- Degree of protection: IP67
- Sealing: NBR
- Dimensions: Ø 60 × 49.5 mm, 17.5 mm inside the enclosure
- Water flow rate: 200 ml/hod
- Mounting: vertically at the lowest point, thread M50x1.5 with nut (Cut-out diameter 50 mm)

Code	Package
ID-EO-DD	1 pc

PRESSURE COMPENSATOR



- Mounting: PG 29 thread with union-nut (cut-out diameter 37 mm)
- Mounting position: any position (installation other than vertical reduces the degree of protection to IP54)
- Material: plastic according to UL94 V-0, light grey RAL 7035
- Degree of protection: IP 55
- Dimensions: Ø 65.5 × 30.5 mm

Code	Package
ID-EO-PC	2 ks

CABLE GLANDS AND NUTS WITH PG/METRIC THREAD



- Material: Polyamide PA6, sealing CR (neoprene)
- Degree of protection: IP68
- Color: RAL 7035

Code	Description	Thread/size	cable Ø (mm)	Package
ORO-PG7N	Sealing grommet Pg7	Pg7	2.5 – 6.5	10 pcs
ORO-PG9N	Sealing grommet Pg9	Pg9	3 – 8	5 pcs
ORO-PG11N	Sealing grommet Pg11	Pg11	4 – 10	5 pcs
ORO-PG13N	Sealing grommet Pg13	Pg13	5.5 – 12	5 pcs
ORO-PG16N	Sealing grommet Pg16	Pg16	8.5 – 14	5 pcs
ORO-PG21N	Sealing grommet Pg21	Pg21	11 – 18	5 pcs
ORO-PG29N	Sealing grommet Pg29	Pg29	17 – 25	5 pcs
ORO-PG36N	Sealing grommet Pg36	Pg36	22 – 33	1 pc
ORO-PG42N	Sealing grommet Pg42	Pg42	28 – 38	1 pc
ORO-PG48N	Sealing grommet Pg48	Pg48	32 – 44	1 pc
ORO-ZPG7N	Plastic nut with flange Pg7	Pg7	–	10 pcs
ORO-ZPG9N	Plastic nut with flange Pg9	Pg9	–	5 pcs
ORO-ZPG11N	Plastic nut with flange Pg11	Pg11	–	5 pcs
ORO-ZPG13N	Plastic nut with flange Pg13	Pg13	–	5 pcs
ORO-ZPG16N	Plastic nut with flange Pg16	Pg16	–	5 pcs
ORO-ZPG21N	Plastic nut with flange Pg21	Pg21	–	5 pcs
ORO-ZPG29N	Plastic nut with flange Pg29	Pg29	–	5 pcs
ORO-ZPG36N	Plastic nut with flange Pg36	Pg36	–	1 pc
ORO-ZPG42N	Plastic nut with flange Pg42	Pg42	–	1 pc
ORO-ZPG48N	Plastic nut with flange Pg48	Pg48	–	1 pc
ORO-M12N	Sealing grommet M12×1.5	M12×1.5	2.5 – 6.5	10 pcs
ORO-M16N	Sealing grommet M16×1.5	M16×1.5	4.5 – 10	5 pcs
ORO-M20N	Sealing grommet M20×1.5	M20×1.5	7 – 13	5 pcs
ORO-M25N	Sealing grommet M25×1.5	M25×1.5	10 – 17	5 pcs
ORO-M32N	Sealing grommet M32×1.5	M32×1.5	17 – 25	5 pcs
ORO-ZM12N	Plastic nut with flange M12×1.5	M12×1.5	–	10 pcs
ORO-ZM16N	Plastic nut with flange M16×1.5	M16×1.5	–	5 pcs
ORO-ZM20N	Plastic nut with flange M20×1.5	M20×1.5	–	5 pcs
ORO-ZM25N	Plastic nut with flange M25×1.5	M25×1.5	–	5 pcs
ORO-ZM32N	Plastic nut with flange M32×1.5	M32×1.5	–	5 pcs

EARTHING



- Supply includes:
 - ID-W-EK: complete earthing kit for whole enclosures
 - ID-W-EW68/EW88/EW8816: cable length 300 mm with crimped lugs

Code	Description	Package
ID-W-EK	Earthing kit WME	1 set *
ID-W-EW68	Grounding wires M6, M8 (door, enclosure), cross-section 10 mm ²	10 ks
ID-W-EW88	Grounding wires M8, M8 (enclosure, mounting plate), cross-section 10 mm ²	10 ks
ID-W-EW8816	Grounding wires M8, M8 (enclosure, mounting plate), cross-section 16 mm ²	10 ks

* Set contains: nuts, screws for earthing door(s), enclosure and mounting plate.

BAYING KIT



- Sealing material: polyethylene foam PNO1
- Sealing: 15 mm wide and 10 mm thick
- In accordance with IP55 degree of protection
- Supply includes: complete set for connecting enclosures and connecting material

Code	Minimum enclosure wall dimensions H × D (mm)	Outer sealing dimensions H × D (mm)	Maximum hole size H × D (mm)	Package
ID-W-ROW4030	400 × 300	320 × 220	240 × 140	1 set
ID-W-ROW4040	400 × 400	320 × 320	240 × 240	1 set
ID-W-ROW6025	600 × 250	520 × 170	440 × 90	1 set
ID-W-ROW6030	600 × 300	520 × 220	440 × 140	1 set
ID-W-ROW6040	600 × 400	520 × 320	440 × 240	1 set
ID-W-ROW7025	700 × 250	620 × 170	540 × 90	1 set
ID-W-ROW7030	700 × 300	620 × 220	540 × 140	1 set
ID-W-ROW7040	700 × 400	620 × 320	540 × 240	1 set

CABLE GLAND PLATE METAL FULL



- Material: 1.5 mm sheet steel
- Surface finish: epoxypolyester powder coating
- Degree of protection: IP66
- Color: RAL 7035
- Mounting: bottom of enclosure
- Supply includes: full metal gland plate, sealing and mounting accessories

Code	Size	Dimensions W × D (mm)	Package
ID-W-CG01A	A	90 × 150	1 pc
ID-W-CG01B	B	90 × 250	1 pc
ID-W-CG01C	C	140 × 250	1 pc
ID-W-CG01D	D	140 × 350	1 pc
ID-W-CG01E	E	140 × 450	1 pc
ID-W-CG01F	F	140 × 550	1 pc

GLAND PLATE WITH ROUND CABLE-ENTRY PLATE



- Material:
 - Bottom: varnished sheet steel
 - Round cable entry plate: polyamide/elastomer, UL-94 Vo self-extinguishing
- Degree of protection: IP66
- Amount of cables: 7×3.2—6.5 mm; 2×5.0—10.2 mm; 1×16.0—22.2 mm
- Mounting: in the opening at the bottom of enclosure instead of full-metal gland plate
- Supply includes: gland plate with round cable-entry plate

Code	Size	Round cable entry plate	Package
ID-W-CG03B	B	50/10	1 pc
ID-W-CG03C	C	50/10	1 pc
ID-W-CG03D	D	50/10	1 pc
ID-W-CG03E	E	50/10	1 pc
ID-W-CG03F	F	50/10	1 pc

GLAND PLATE WITH CABLE-ENTRY FRAME AND CABLE INSERTS

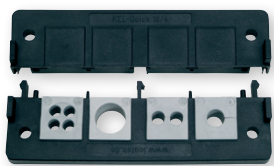

- Material:
 - Bottom: varnished sheet steel
 - Cable inserts: elastomer, UL-94 Vo, self-extinguishing
 - Cable-entry frame: polyamide, UL-94 Vo, self-extinguishing
- Frame size: 120 × 58 mm, 8 positions for cable inserts ID-W-CExx
- Degree of protection: IP54
- Amount of cables: see cable insert ID-W-CExx
- Mounting: in the opening at the bottom of enclosure instead of full metal gland plate
- Supply includes: gland plate with cable-entry frame with holes

Gland plate with cable-entry frame

Code	Gland plate size	Frame size W x D (mm)	Amount of positions ID-W-CExx	Package
ID-W-CG02B	B	120 × 58	8	1 pc
ID-W-CG02C	C	120 × 58	8	1 pc
ID-W-CG02D	D	120 × 58	8	1 pc
ID-W-CG02E	E	120 × 58	8	1 pc
ID-W-CG02F	F	120 × 58	8	1 pc

Cable inserts

Code	Ø (mm)	Package
ID-W-CEP	cable blind ID-W-CG02x	1 pc
ID-W-CE3	3-4	1 pc
ID-W-CE4	4-5	1 pc
ID-W-CE5	5-6	1 pc
ID-W-CE6	6-7	1 pc
ID-W-CE7	7-8	1 pc
ID-W-CE8	8-9	1 pc
ID-W-CE9	9-10	1 pc
ID-W-CE10	10-11	1 pc
ID-W-CE11	11-12	1 pc
ID-W-CE12	12-13	1 pc
ID-W-CE13	13-14	1 pc
ID-W-CE14	14-15	1 pc
ID-W-CE2/3	2×3	1 pc
ID-W-CE2/4	2×4	1 pc
ID-W-CE2/5	2×5	1 pc
ID-W-CE2/5.5	2×5.5	1 pc
ID-W-CE2/6	2×6	1 pc
ID-W-CE2/6.5	2×6.5	1 pc
ID-W-CE2/7	2×7	1 pc
ID-W-CE4/3	4×3	1 pc
ID-W-CE4/4	4×4	1 pc
ID-W-CE4/4.5	4×4.5	1 pc
ID-W-CE4/5	4×5	1 pc
ID-W-CE4/5.5	4×5.5	1 pc
ID-W-CE4/6	4×6	1 pc

MEMBRANE ENTRY



- Material: polyamide/elastomer, UL-94 Vo, self-extinguishing
- Degree of protection: IP64
- Installation: cut-outs into cable glands
- Supply includes: 1 pc membrane
- Cut-outs for installation in the CONTEG Modification Center

Code	Sizes W x D (mm)	Cables	Package
ID-W-ME24/19	142 × 44	12× max Ø 6.5 mm; 7× Ø 2.1 mm	1 pc
ID-W-ME24/48	142 × 44	48× max Ø 6.5 mm	1 pc

CLIMATE CONTROL SOLUTIONS FOR WME, WME-G FILTER FANS



MAIN ADVANTAGES

- Quick assembly without screws and tools into a square cut-out, easy to mount with highly elastic clips
- Easy filter insert replacement from the outside without tools
- Possible to change airflow direction
- Airflow up to 800 m³/h
- Can be mounted in a enclosure with a sheet thickness of 1-2.5 mm
- IP 54 standard degree of protection
- Side and top ventilator placement
- Operating temperature range -10 °C up to +70 °C
- Polyurethane foam sealing around the whole perimeter
- Resistance against UV radiation
- Holes for installation in the CONTEG Modification Center

DESCRIPTION

- Plastic parts made of ABS/PC mix, all parts are self-extinguishing according to UL 94V-0
- Standard color RAL 7035 (different color on request)
- Filter inserts made of synthetic fibres of class G3 according to EN

779 and class G4 according to EN 779 and UL 900 class 2 self-extinguishing in class F1 according to DIN 53 438

- Filter inserts are cleaned by washing, compressed air and banging

- Encapsulated fan ball bearings
- IP54 standard degree of protection EN 60529 and NEMA 12 according to UL 50
- IP55 settable (according to EN 60529)

- IP56 when using protective cover against splashing water
- EMC version available on request

Fans

Code	Airflow	Dimensions H × W × D	Voltage **	Frequency	Outlet filter grid	Cut-out dimensions	Degree of protection
ID-EF-01-4	12/15 m ³ /h	106.5 × 106.5 × 59.9 mm	230 VAC	50/60 Hz	ID-EF-01	92 × 92 mm	IP54
ID-EF-01-1	15 m ³ /h	106.5 × 106.5 × 59.9 mm	24 VDC	–	ID-EF-01	92 × 92 mm	IP54
ID-EF-04-4	45/50 m ³ /h	150 × 150 × 65.5 mm	230 VAC	50/60 Hz	ID-EF-03	125 × 125 mm	IP54
ID-EF-04-1	47 m ³ /h	150 × 150 × 65.5 mm	24 VDC	–	ID-EF-03	125 × 125 mm	IP54
ID-EF-10-4	100/110 m ³ /h	203.9 × 203.9 × 87.5 mm	230 VAC	50/60 Hz	ID-EF-05	177 × 177 mm	IP54
ID-EF-10-1	100 m ³ /h	203.9 × 203.9 × 87.5 mm	24 VDC	–	ID-EF-05	177 × 177 mm	IP54
ID-EF-23-4	230/270 m ³ /h	250 × 250 × 115.3 mm	230 VAC	50/60 Hz	ID-EF-07	223 × 223 mm	IP54
ID-EF-22-1	225 m ³ /h	250 × 250 × 115.3 mm	24 VDC	–	ID-EF-07	223 × 223 mm	IP54
ID-EF-52-4	520/580 m ³ /h	325 × 325 × 150.7 mm	230 VAC	50/60 Hz	ID-EF-09	291 × 291 mm	IP54
ID-EF-71-4	710/800 m ³ /h	325 × 325 × 149 mm	230 VAC	50/60 Hz	ID-EF-09	291 × 291 mm	IP54
ID-EFT-42-4 *	420/490 m ³ /h	324 × 324 × 94 mm	230 VAC	50/60 Hz	ID-EF-09	fan 175 × 175 mm/grid 291 × 291 mm	IP54
ID-EO-TC	Thermostat for cooling	55 × 33 × 43 mm	250 VAC/10 A	–	–	–	IP20

* Top version.

** Other input voltage options available upon request.



For more detailed information, please refer to the product catalog "Climate control solutions" at www.conteg.com or contact our sales representatives.

WME, WME-G—COMPACT ENCLOSURES

TECHNICAL DRAWINGS

WME—compact enclosures—sheet steel and with glazed doors, single-door versions with a rotary lock

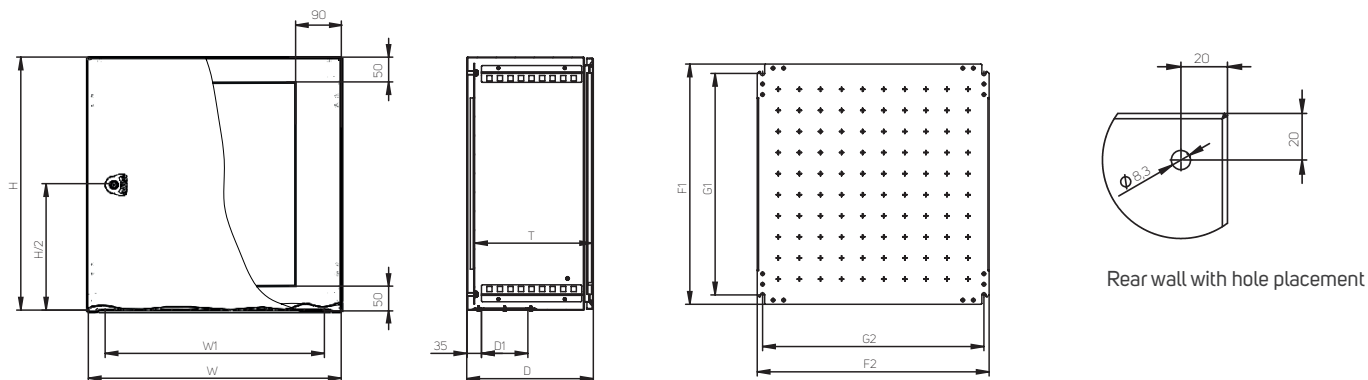

Code **	Height (mm)		Width (mm)		Depth (mm)				Mounting plate (mm)				Material thickness (mm)			Cable gland plate		Cable-entry	
	H	W	D	T*	F1	F2	G1	G2	Enclosure	Door	Mounting plate	Size	Number	W1	D1				
WME-030215	300	200	155	135	270	150	225	125	1.25	1.5	2.0	A	1	120	60				
WME-032515	300	250	155	135	270	200	225	175	1.25	1.5	2.0	A	1	120	60				
WME-030315	300	300	155	135	270	250	225	225	1.25	1.5	2.0	B	1	220	60				
WME-030321	300	300	210	190	270	250	225	225	1.25	1.5	2.0	C	1	220	110				
WME-030415	300	400	155	135	270	350	225	325	1.25	1.5	2.0	B	1	220	60				
WME-030421	300	400	210	190	270	350	225	325	1.25	1.5	2.0	D	1	320	110				
WME-040315	400	300	155	135	370	250	325	225	1.25	1.5	2.0	B	1	220	60				
WME-040321	400	300	210	190	370	250	325	225	1.25	1.5	2.0	C	1	220	110				
WME-040421	400	400	210	190	370	350	325	325	1.25	1.5	2.5	D	1	320	110				
WME-040621	400	600	210	190	370	550	325	525	1.25	1.5	2.5	F	1	520	110				
WME-040625	400	600	250	230	370	550	325	525	1.25	1.5	2.5	F	1	520	110				
WME-050321	500	300	210	190	470	250	425	325	1.25	1.5	2.0	C	1	220	110				
WME-050421	500	400	210	190	470	350	425	325	1.25	1.5	2.5	D	1	320	110				
WME-050425	500	400	250	230	470	350	425	325	1.25	1.5	2.5	D	1	320	110				
WME-050521	500	500	210	190	470	450	425	425	1.25	1.5	2.5	E	1	420	110				
WME-050503	500	500	300	280	470	450	425	425	1.25	1.5	2.5	E	1	420	110				
WME-060421	600	400	210	190	570	350	525	325	1.25	1.5	2.5	D	1	320	110				
WME-060425	600	400	250	230	570	350	525	325	1.50	2.0	2.5	D	1	320	110				
WME-060403	600	400	300	280	570	350	525	325	1.50	2.0	2.5	D	1	320	110				
WME-060525	600	500	250	230	570	450	525	425	1.50	2.0	2.5	E	1	420	110				
WME-060621	600	600	210	190	570	550	525	525	1.50	2.0	2.5	F	1	520	110				
WME-060625	600	600	250	230	570	550	525	525	1.50	2.0	2.5	F	1	520	110				
WME-060603	600	600	300	280	570	550	525	525	1.50	2.0	2.5	F	1	520	110				
WME-060604	600	600	400	380	570	550	525	525	1.50	2.0	2.5	F	1	520	110				
WME-060825	600	800	250	230	570	750	525	725	1.50	2.0	2.5	F	1	520	110				
WME-060803	600	800	300	280	570	750	525	725	1.50	2.0	2.5	F	1	520	110				

* T Dimension specifies the depth between the mounting plate and the inside of the door, the door trim reduces this value by 17 mm and the lock by 31 mm.

** Valid also for order code WME-G-xxxxxx.

WME—compact enclosures—sheet steel and with glazed doors, single-door versions with two rotary locks

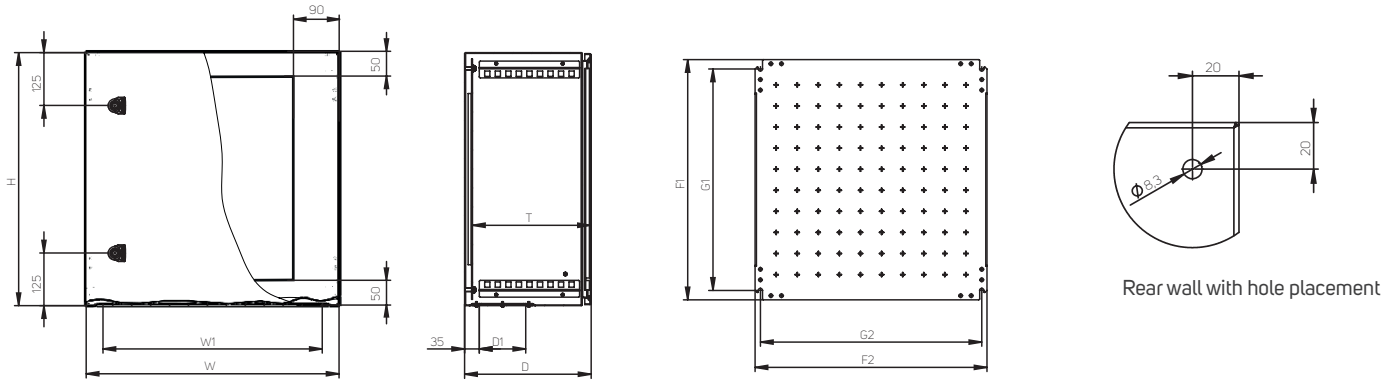

Code **	Height (mm)	Width (mm)	Depth (mm)		Mounting plate (mm)				Material thickness (mm)			Cable gland plate		Cable-entry	
	H	W	D	T*	F1	F2	G1	G2	Enclosure	Door	Mounting plate	Size	Number	W1	D1
WME-070521	700	500	210	190	670	450	625	425	1.50	2.0	2.5	E	1	420	110
WME-070503	700	500	300	280	670	450	625	425	1.50	2.0	2.5	E	1	420	110
WME-080625	800	600	250	230	770	550	725	525	2.0	2.0	3 F	F	1	520	110
WME-080603	800	600	300	280	770	550	725	525	2.0	2.0	3 F	F	1	520	110
WME-080604	800	600	400	380	770	550	725	525	2.0	2.0	3 F	F	1	520	110
WME-080803	800	800	300	280	770	750	725	725	2.0	2.0	3 FF	F	1	520	110
WME-080804	800	800	400	380	770	750	725	725	2.0	2.0	3 FF	F	1	520	110

3 F—3mm mounting plate with 2 bent edges. 3 FF—3mm mounting plate with 4 bent edges.

* T Dimension specifies the depth between the mounting plate and the inside of the door, the door trim reduces this value by 17 mm and the lock by 31 mm.

** Valid also for order code WME-G-xxxxxx.

WME—compact enclosures—sheet steel and with glazed doors, single-door versions with 3-point lock system

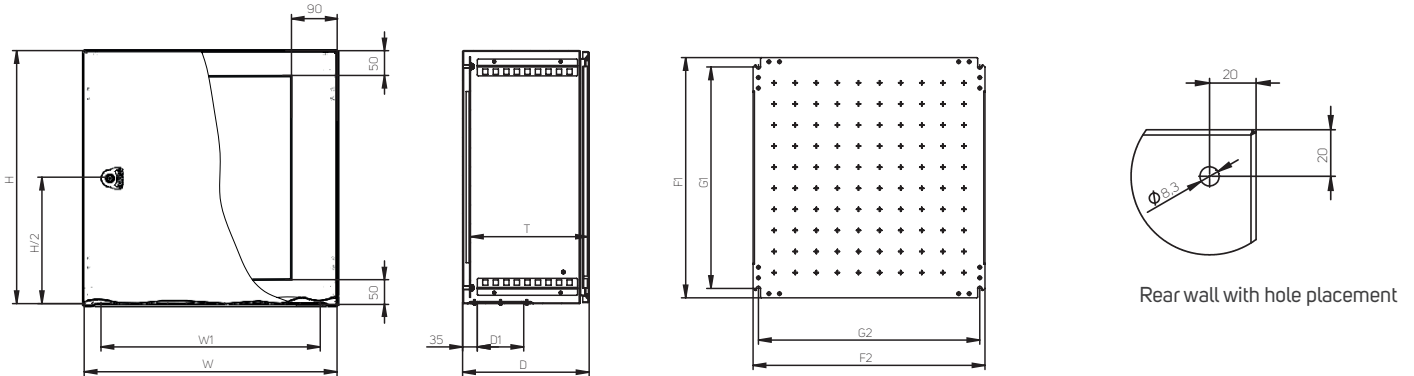

Code **	Height (mm)	Width (mm)	Depth (mm)		Mounting plate (mm)				Tloušťka materiálu v mm			Cable gland plate		Cable-entry	
	H	W	D	T*	F1	F2	G1	G2	Enclosure	Door	Mounting plate	Size	Number	W1	D1
WME-100625	1000	600	300	280	970	550	925	525	2.0	2.0	3 F	F	1	520	110
WME-100603	1000	600	300	280	970	550	925	525	2.0	2.0	3 F	F	1	520	110
WME-100604	1000	600	400	380	970	550	925	525	2.0	2.0	3 F	F	1	520	110
WME-100803	1000	800	300	280	970	750	925	725	2.0	2.0	3 FF	F	1	520	110
WME-100804	1000	800	400	380	970	750	925	725	2.0	2.0	3 FF	F	1	520	110
WME-120603	1200	600	300	280	1170	550	1125	525	2.0	2.0	3 F	F	1	520	110
WME-120604	1200	600	400	380	1170	550	1125	525	2.0	2.0	3 F	F	1	520	110
WME-120803	1200	800	300	280	1170	750	1125	725	2.0	2.0	3 FF	F	1	520	110
WME-120804	1200	800	400	380	1170	750	1125	725	2.0	2.0	3 FF	F	1	520	110

3 F—3mm mounting plate with 2 bent edges. 3 FF—3mm mounting plate with 4 bent edges.

* T Dimension specifies the depth between the mounting plate and the inside of the door, the door trim reduces this value by 17 mm and the lock by 31 mm.

** Valid also for order code WME-G-xxxxxx.

WME—compact enclosures—sheet steel and with glazed doors, double-door versions with 3-point lock system

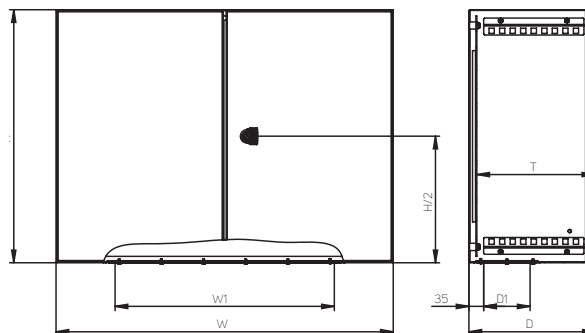
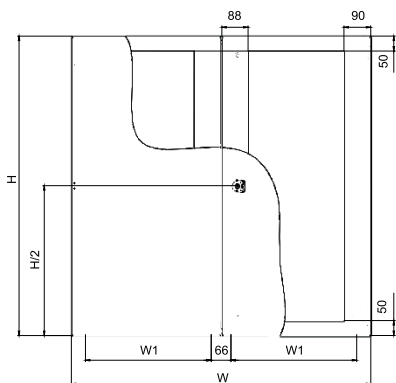

Only for WME-160803 and WME-G-160803 enclosures

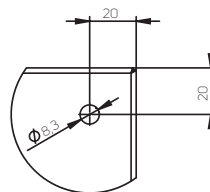
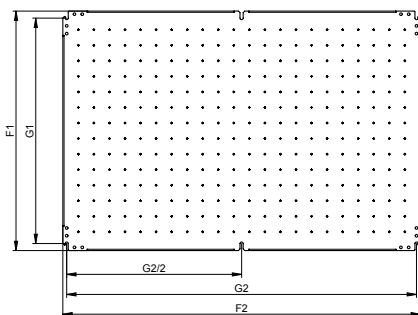

Rear wall with hole placement

Code **	Height (mm)		Width (mm)		Depth (mm)				Mounting plate (mm)				Material thickness (mm)			Cable gland plate		Cable-entry	
	H	W	D	T *	F1	F2	G1	G2	Enclosure	Door	Mounting plate	Size	Number	W1	D1				
WME-160803	600	800	300	280	570	750	525	725	1.5	1.5	2.5	F	1	520	110				
WME-181003	800	1000	300	280	770	950	725	925	1.5	2.0	3 FF	E	2	420	110				
WME-181203	800	1200	300	280	770	1150	725	1125	1.5	2.0	3 FF	F	2	520	110				
WME-201003	1000	1000	300	280	970	950	925	925	1.5	2.0	3 FF	E	2	420	110				
WME-201004	1000	1000	400	380	970	950	925	925	1.5	2.0	3 FF	E	2	420	110				
WME-201203	1000	1200	300	280	970	1150	925	1125	1.5	2.0	3 FF	F	2	520	110				
WME-201204	1000	1200	400	380	970	1150	925	1125	1.5	2.0	3 FF	F	2	520	110				
WME-221003	1200	1000	300	280	1170	950	1125	925	1.5	2.0	3 FF	E	2	420	110				
WME-221004	1200	1000	400	380	1170	950	1125	925	1.5	2.0	3 FF	E	2	420	110				
WME-221203	1200	1200	300	280	1170	1150	1125	1125	1.5	2.0	3 FF	F	2	520	110				
WME-221204	1200	1200	400	380	1170	1150	1125	1125	1.5	2.0	3 FF	F	2	520	110				
WME-241003	1400	1000	300	280	1370	950	1325	925	1.5	2.0	3 FF	E	2	420	110				

3 FF—3mm mounting plate with 4 bent edges.

* T Dimension specifies the depth between the mounting plate and the inside of the door, the door trim reduces this value by 17 mm and the lock by 31 mm.

** Valid also for order code WME-G-xxxxx.

Cable gland plate metal full for compact enclosures – sheet steel

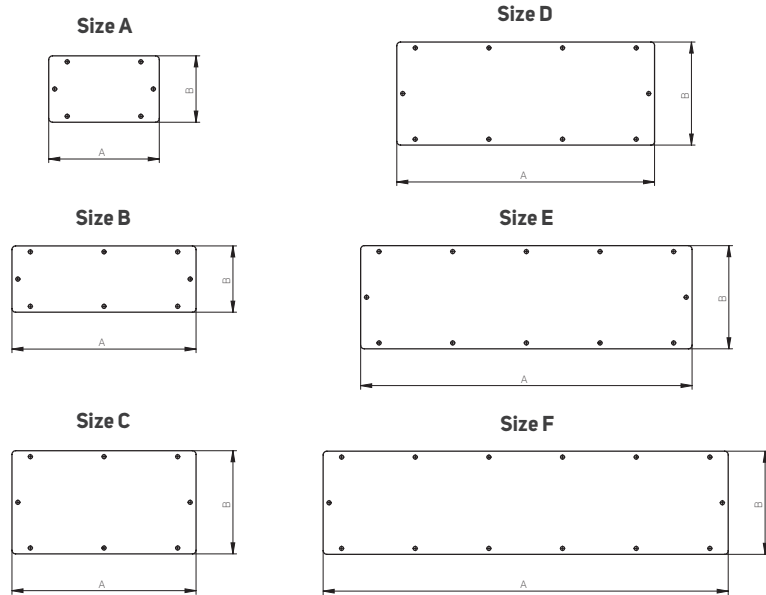

Size	Width A (mm)	Depth B (mm)
A	150	90
B	250	90
C	250	140
D	350	140
E	450	140
F	550	140

HEAT LOSS DISPERSION

WME—sheet steel compact enclosures—
measured with heat inside enclosure $\Delta T = 15 \text{ K}$

Code	Enclosure dimensions (mm)			Thickness of the material (mm)		Number of doors (pcs)	Total area of enclosure (m ²)	Total power dissipation (W)
	Height	Width	Depth	Body	Door			
WME-030215	300	200	155	1.25	1.50	1	0.215	11.5
WME-032515	300	250	155	1.25	1.50	1	0.321	16.5
WME-030315	300	300	155	1.25	1.50	1	0.366	19.0
WME-030321	300	300	210	1.25	1.50	1	0.432	21.8
WME-030415	300	400	155	1.25	1.50	1	0.457	24.1
WME-030421	300	400	210	1.25	1.50	1	0.534	27.3
WME-040315	400	300	155	1.25	1.50	1	0.457	24.1
WME-040321	400	300	210	1.25	1.50	1	0.534	27.3
WME-040421	400	400	210	1.25	1.50	1	0.656	34.1
WME-040621	400	600	210	1.25	1.50	1	0.900	47.6
WME-040625	400	600	250	1.25	1.50	1	0.980	50.9
WME-050321	500	300	210	1.25	1.50	1	0.636	32.8
WME-050421	500	400	210	1.25	1.50	1	0.778	40.8
WME-050425	500	400	250	1.25	1.50	1	0.850	43.8
WME-050521	500	500	210	1.25	1.50	1	0.920	48.8
WME-050503	500	500	300	1.25	1.50	1	1.100	56.4
WME-060421	600	400	210	1.25	1.50	1	0.900	47.6
WME-060425	600	400	250	1.50	1.50	1	0.980	50.4
WME-060403	600	400	300	1.50	1.50	1	1.080	54.5
WME-060525	600	500	250	1.50	1.50	1	1.150	59.9
WME-060621	600	600	210	1.50	1.50	1	1.224	65.4
WME-060625	600	600	250	1.50	1.50	1	1.320	69.4
WME-060603	600	600	300	1.50	1.50	1	1.440	74.3
WME-060604	600	600	400	1.50	1.50	1	1.680	84.2
WME-060825	600	800	250	1.50	1.50	1	1.660	88.3
WME-060803	600	800	300	1.50	1.50	1	1.800	94.1
WME-070521	700	500	210	1.50	1.50	1	1.204	64.2
WME-070503	700	500	300	1.50	1.50	1	1.420	73.1
WME-080625	800	600	250	1.50	2.00	1	1.660	87.8
WME-080603	800	600	300	1.50	2.00	1	1.800	93.6
WME-080604	800	600	400	1.50	2.00	1	2.080	105.2
WME-080803	800	800	300	1.50	2.00	1	2.240	118.2
WME-080804	800	800	400	1.50	2.00	1	2.560	131.4
WME-100625	1000	600	250	1.50	2.00	1	2.000	106.7
WME-100603	1000	600	300	1.50	2.00	1	2.160	113.3
WME-100604	1000	600	400	1.50	2.00	1	2.480	126.5
WME-100803	1000	800	300	1.50	2.00	1	2.680	142.8
WME-100804	1000	800	400	1.50	2.00	1	3.040	157.6
WME-120603	1200	600	300	1.50	2.00	1	2.520	133.0
WME-120604	1200	600	400	1.50	2.00	1	2.880	147.8
WME-120803	1200	800	300	1.50	2.00	1	3.120	167.4
WME-120804	1200	800	400	1.50	2.00	1	3.520	183.9
WME-160803	600	800	300	1.50	1.50	2	1.800	94.1
WME-181003	800	1000	300	1.50	2.00	2	2.680	142.8
WME-181203	800	1200	300	1.50	2.00	2	3.120	167.4
WME-201003	1000	1000	300	1.50	2.00	2	3.200	172.3
WME-201004	1000	1000	400	1.50	2.00	2	3.600	188.8
WME-201203	1000	1200	300	1.50	2.00	2	3.720	201.8
WME-201204	1000	1200	400	1.50	2.00	2	4.160	220.0
WME-221003	1200	1000	300	1.50	2.00	2	3.720	201.8
WME-221004	1200	1000	400	1.50	2.00	2	4.160	220.0
WME-221203	1200	1200	300	1.50	2.00	2	4.320	236.2
WME-221204	1200	1200	400	1.50	2.00	2	4.800	256.0
WME-241003	1400	1000	300	1.50	2.00	2	4.240	231.3

WME-G—sheet steel compact enclosures with glazed doors—
measured with heat inside enclosure $\Delta T = 15\text{ K}$

Code	Enclosure dimensions (mm)			Thickness of the material (mm)		# of doors (pcs)	Total area of enclosure (m ²)	Total power dissipation (W)
	Height	Width	Depth	Body	Door (glass)			
WME-G-032515	300	250	155	1.25	4.00	1	0.321	13.6
WME-G-030315	300	300	155	1.25	4.00	1	0.366	15.6
WME-G-030321	300	300	210	1.25	4.00	1	0.432	18.3
WME-G-030415	300	400	155	1.25	4.00	1	0.457	19.5
WME-G-030421	300	400	210	1.25	4.00	1	0.534	22.7
WME-G-040315	400	300	155	1.25	4.00	1	0.457	19.5
WME-G-040321	400	300	210	1.25	4.00	1	0.534	22.7
WME-G-040421	400	400	210	1.25	4.00	1	0.656	27.9
WME-G-040621	400	600	210	1.25	4.00	1	0.900	38.3
WME-G-040625	400	600	250	1.25	4.00	1	0.980	41.7
WME-G-050321	500	300	210	1.25	4.00	1	0.636	27.0
WME-G-050421	500	400	210	1.25	4.00	1	0.778	33.1
WME-G-050425	500	400	250	1.25	4.00	1	0.850	36.1
WME-G-050521	500	500	210	1.25	4.00	1	0.920	39.2
WME-G-050503	500	500	300	1.25	4.00	1	1.100	46.7
WME-G-060421	600	400	210	1.25	4.00	1	0.900	38.3
WME-G-060425	600	400	250	1.50	4.00	1	0.980	41.1
WME-G-060403	600	400	300	1.50	4.00	1	1.080	45.2
WME-G-060525	600	500	250	1.50	4.00	1	1.150	48.3
WME-G-060621	600	600	210	1.50	4.00	1	1.224	51.5
WME-G-060625	600	600	250	1.50	4.00	1	1.320	55.5
WME-G-060603	600	600	300	1.50	4.00	1	1.440	60.4
WME-G-060604	600	600	400	1.50	4.00	1	1.680	70.3
WME-G-060825	600	800	250	1.50	4.00	1	1.660	69.8
WME-G-060803	600	800	300	1.50	4.00	1	1.800	75.6
WME-G-070521	700	500	210	1.50	4.00	1	1.204	50.6
WME-G-070503	700	500	300	1.50	4.00	1	1.420	59.6
WME-G-080625	800	600	250	1.50	4.00	1	1.660	69.8
WME-G-080603	800	600	300	1.50	4.00	1	1.800	75.6
WME-G-080604	800	600	400	1.50	4.00	1	2.080	87.2
WME-G-080803	800	800	300	1.50	4.00	1	2.240	94.2
WME-G-080804	800	800	400	1.50	4.00	1	2.560	107.4
WME-G-100625	1000	600	250	1.50	4.00	1	2.000	84.2
WME-G-100603	1000	600	300	1.50	4.00	1	2.160	90.8
WME-G-100604	1000	600	400	1.50	4.00	1	2.480	104.0
WME-G-100803	1000	800	300	1.50	4.00	1	2.680	112.8
WME-G-100804	1000	800	400	1.50	4.00	1	3.040	127.6
WME-G-120603	1200	600	300	1.50	4.00	1	2.520	106.0
WME-G-120604	1200	600	400	1.50	4.00	1	2.880	120.8
WME-G-120803	1200	800	300	1.50	4.00	1	3.120	131.4
WME-G-120804	1200	800	400	1.50	4.00	1	3.520	147.9
WME-G-160803	600	800	300	1.50	4.00	2	1.800	75.6
WME-G-181003	800	1000	300	1.50	4.00	2	2.680	112.8
WME-G-181203	800	1200	300	1.50	4.00	2	3.120	131.4
WME-G-201003	1000	1000	300	1.50	4.00	2	3.200	134.8
WME-G-201004	1000	1000	400	1.50	4.00	2	3.600	151.3
WME-G-201203	1000	1200	300	1.50	4.00	2	3.720	156.8
WME-G-201204	1000	1200	400	1.50	4.00	2	4.160	175.0
WME-G-221003	1200	1000	300	1.50	4.00	2	3.720	156.8
WME-G-221004	1200	1000	400	1.50	4.00	2	4.160	175.0
WME-G-221203	1200	1200	300	1.50	4.00	2	4.320	182.2
WME-G-221204	1200	1200	400	1.50	4.00	2	4.800	202.0
WME-G-241003	1400	1000	300	1.50	4.00	2	4.240	178.8

CONTEG, spol. s r.o.

Stetkova 1638/18

140 00 Prague 4

Czech Republic

Tel.: +420 565 300 358

conteg@conteg.com

www.conteg.com

CONTEG